

MEGAL

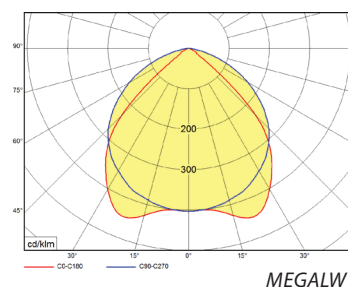
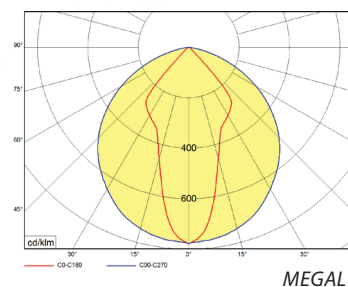
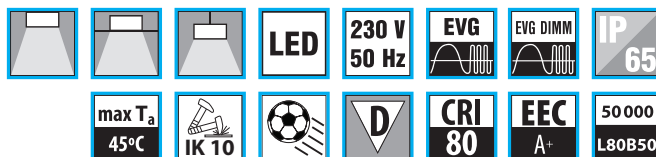

Průmyslová LED svítidla

Těleso:

Bíle práškově lakovaný (RAL9003) ocelový plech

Optický systém:

Vysoce leštěné parabolické hliníkové reflektory aluminium MIRO®
MEGAL... hlubokozářič 35°
MEGAL W... širokozářič 90°

Kryt:

Čiré tvrzené sklo (standard)
PC – čirý polykarbonát, odolnost IK10
PCO – opalový polykarbonát, odolnost IK10
KN – mikroprimatický PMMA
PCN – mikroprizmatický kryt (certifikace pro použití v tělocvičnách dle DIN VDE 0710-13)

LED

Mid Power LED
CRI 80 (CRI 90 na vyžádání)
3...teplá bílá 3000K
4...studená bílá 4000K
5...denní světlo 5700K

El. výstroj:

Proudový LED driver
ND – nestmívatelný (standard)
DALI – digitalně stmívatelný DALI

Aplikace:

- obchodní prostory, montážní a skladové haly - jako úsporná alternativa k zářivkovým nebo výbojkovým svítidlům

Montáž:

- závěsná montáž
- svítidla jsou osazena 4 oky s karabinou pro snadné zavěšení pomocí řetízků nebo lanek s očkem
- pro připojení k síti jsou svítidla osazena kabelem s IP65 konektorem IK10 – volitelná varianta svítidla s vyšší mech. odolností, za použití krytu PC, PCO nebo PCN

Příslušenství:

MEGAMONTSET - držák pro přisazenou montáž
MEGAVESTRAM - držák pro vestavnou montáž svítidel 4S
MEGALPIR - senzor pro svítidla MEGAL

LED high-bays

Body:

White painted (RAL9003) metal sheet

Optic:

Highly polished reflectors made of MIRO® aluminium
MEGAL... narrow beam 35°
MEGAL W... wide beam 90°

Cover:

Clear hardened glass (standard)
PC – clear polycarbonate, mechanical resistance IK10
PCO – opal polycarbonate, mechanical resistance IK10
KN – mikroprizmatický PMMA
PCN – mikroprizmatický kryt (certifikace pro sportovní haly dle DIN VDE 0710-13)

LED

Mid Power LED
CRI 80 (CRI 90 on request)
3...warm white 3000K
4...cold white 4000K
5...daylight 5700K

Wiring:

Constant current LED driver
ND – not dimmable (standard)
DALI – dimmable DALI

Application:

Supermarkets, assembly halls, stocks, etc. – as an alternative for discharge or fluorescent lamp luminaires

Assembly:

Pendant installation.
Fixtures are equipped with 4 snap hooks for easy hanging by chains or ropes with eyelet.
To connect to the power are fittings equipped with cable with IP65 connector.
IK10 – available version with higher resistance, with cover PC, PCO or PCN

Accessories:

MEGAMONTSET - a holder for surface assembly
MEGAVESTRAM - a holder for recessed installation of MEGAL 4S
MEGALPIR - senzor for MEGAL

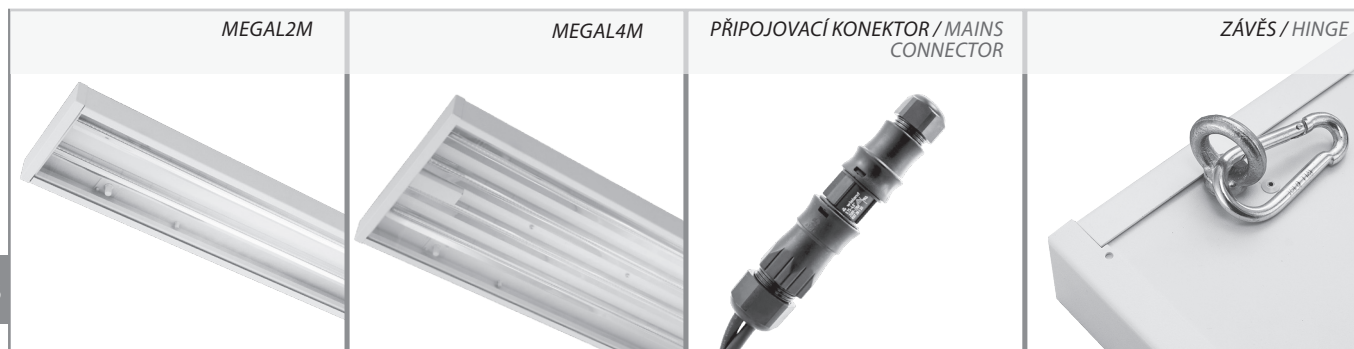

Kódové označení svítidla / codes: MEGAL2M4V1/2100ND

MEGAL	2	M	4	PC	V1	/2100ND
Typ svítidla / Luminaire type: MEGAL - hlubokozářič / narrow beam MEGALW - širokozářič / wide beam	Počet svítících pruhů / Nr of lighting strips	Délka korpusu / Body length S=600 mm M=1200 mm	Teplota chromatičnosti / Color temperature: 3 = 3000K, 4 = 4000K 5 = 5700K	Typ krytu / Cover type Čiré sklo / clear glass PC - čirý polycarbonát / clear polycarbonate PCO - opálový polycarbonát / opal polycarbonate	Použité LED / Used LEDs	Typ zdroje / Driver type: ND – neregulovatelný zdroj / no dimmable DALI – regulovatelný zdroj dig. stmívatelný DALI / dimmable DALI



MEGAL2S

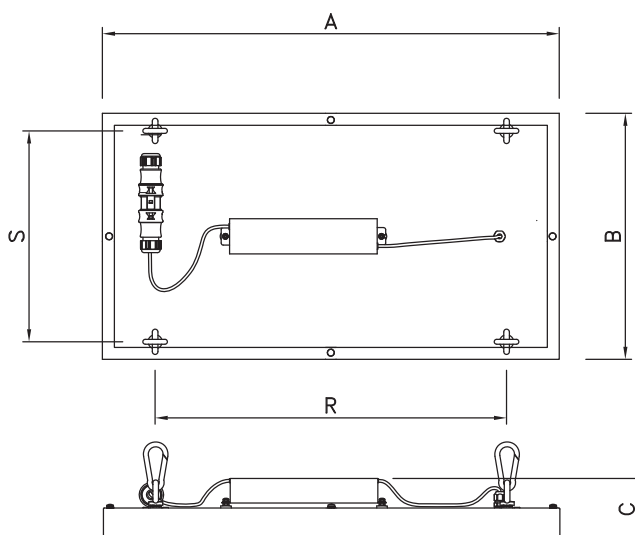

Hlubokozářič, skleněný kryt / Narrow beam, glass cover

	W	lm	lm/W	A	B	C	R	S	kg
MEGAL2S&/1050#	56	6 900	123	655	190	90	500	140	5
MEGAL4S&/2100#	106	14 500	137		350			300	7
MEGAL2M&/2100#				1220	190		940	140	13
MEGAL4M&/4200#	215	29 500	350		300				

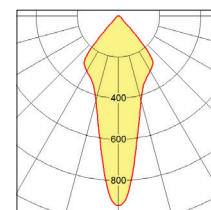

MEGAL



Širokozářič, skleněný kryt / Wide beam, glass cover

	W	lm	lm/W	A	B	C	R	S	kg
MEGALW2S&/1050#	56	7 000	125	650	190	90	500	140	5
MEGALW4S&/1400#	70	10 400	149		350			300	7
MEGALW4S&/2100#	106	15 000	142	1220	190		940	140	
MEGALW2M&/1400#	70	10 400	149		350			18	
MEGALW2M&/2100#	106	15 000	142	1220	190	940	300		13
MEGALW4M&/2800#	140	20 500	146		350		18		
MEGALW4M&/4200#	215	30 000	140	500	18				
MEGALW6M&/2100#	310	44 500	144	500		450	18		

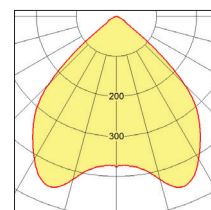

MEGALW

Uvedené údaje mohou být během platnosti tohoto katalogu bez upozornění změněny. Výpadek jednotlivého LED čipu, odchylka světelného toku a příkonu svítidla +/-10% jakož i teploty chromatičnosti +/-150K jsou v souladu s platnými standardy přípustné a nejsou důvodem k reklamaci svítidla. | Due to MODUS program of products development a data can be changed without notice. Luminous flux and connected electrical load are subject to an initial tolerance of up to +/- 10%. Color temperature is subject to a tolerance of up to +/-150 K from the nominal value. The failure of 1 LED points causes no functional impairment to the lighting performance of the luminaire and is therefore no reason for complaint.

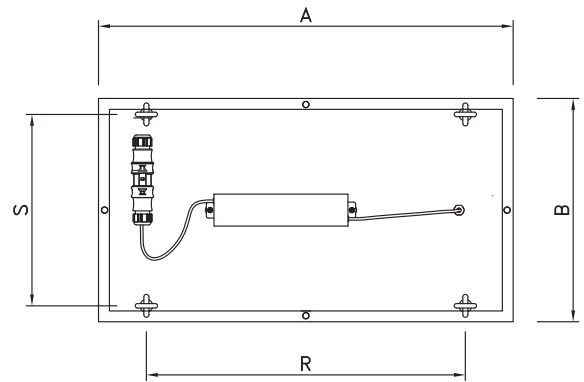
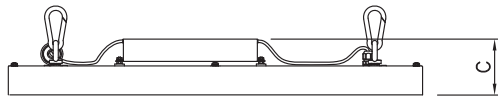

Hlubokozářič, čirý PC kryt / Narrow beam, clear PC cover

	W	Im	lm/W	A	B	C	R	S	kg
MEGAL2S PC&/1050#	56	6 700	120	650	190	90	500	140	4,5
MEGAL4SPC&/2100	106	14 000	132		350			300	
MEGAL2MPC&/2100				1220	190		140	6	
MEGAL4MPC&/4200	215	28 800	134		350		940		300

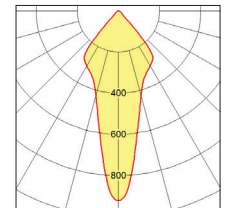

MEGAL PC



Širokozářič, čirý PC kryt / Wide beam, clear PC cover

	W	Im	lm/W	A	B	C	R	S	kg
MEGALW2S&PC/1050#	56	6 800	121	650	190	90	500	140	4,5
MEGALW4S&PC/1400#	70	10 000	143		350			300	
MEGALW4S&PC/2100#	106	14 500	137	1220	190		940	140	6
MEGALW2M&PC/1400#	70	10 000	143		350			300	
MEGALW2M&PC/2100#	106	14 500	137	1220	350	940	140	12	
MEGALW4M&PC/2800#	140	19 900	142				300		
MEGALW4M&PC/4200#	218	29 100	133				450		17
MEGALW6M&PC/6300#	310	43 200	139						

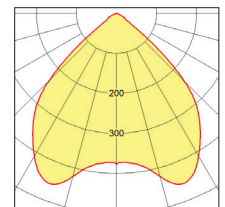

MEGALW PC



Širokozářič, opalový PC kryt / Wide beam, opal PC cover

	W	Im	lm/W	A	B	C	R	S	kg
MEGALW2S&PCO/1050#	56	5 600	100	650	190	90	500	140	4,5
MEGALW4S&PCO/1400#	70	8 400	120		350			300	
MEGALW4S&PCO/2100#	106	12 000	113	1220	190		940	140	6
MEGALW2M&PCO/1400#	70	8 400	120		350			300	
MEGALW2M&PCO/2100#	106	12 000	113	1220	350	940	140	12	
MEGALW4M&PCO/2800#	140	16 700	119				300		
MEGALW4M&PCO/4200#	215	24 000	112				450		17

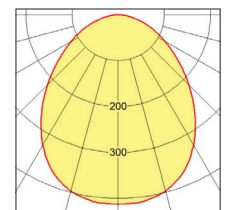

MEGALW PCO



Hlubokozářič, prizmatický PMMA kryt, UGR<22 / Narrow beam, prismatic PMMA cover, UGR<22

	W	Im	lm/W	A	B	C	R	S	kg
MEGAL2S&KN/1050#	56	6 500	116	650	190	90	500	140	4,5
MEGAL4S&KN/2100#	106	13 500	127		350			300	
MEGAL2M&KN/2100#			1220	125	190		140	6	
MEGAL4M&KN/4200#	215	27 600		128	350		940		300

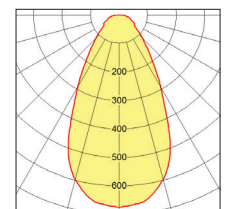

MEGAL KN



Hlubokozářič, prizmatický PC kryt, UGR<22 / Narrow beam, prismatic PC cover, UGR<22

	W	Im	lm/W	A	B	C	R	S	kg
MEGAL4S&PCN/2100#	106	11 400	108	650	350	90	500	300	6
MEGAL2M&PCN/1400#	70	7 900	113	1220	190			940	
MEGAL2M&PCN/2100#	106	11 400	108		350		300		12
MEGAL4M&PCN/2800#	140	15 600	111						
MEGAL4M&PCN/4200#	215	22 700	106						

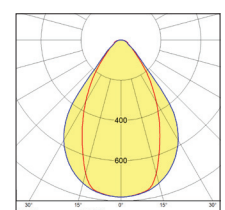

MEGAL PCN

& - 3 = 3000K, 4 = 4000K, 5 = 5700K

Im - světelný výkon svítidla / luminaire light output # - el. výstroj / wiring

MEGAL - PŘÍSLUŠENSTVÍ / ACCESSORIES

MEGAMONTSET

Sada držáků pro přisazenou montáž svítidla MEGAL
Bíle lakovaný ocelový profil
Upevnění ke svítidlu v místech závěsných ok.
Odsazení svítidla od stropu činí 35mm.

MEGAMONTSET

Set of holders for surfaced assembly of MEGAL.
White painted steel profile
Mounting to the body of the luminaire in place eyebolts.
Distance between the fitting and the ceiling is 65 mm

	X	Y	pro svítidlo / for fitting
MEGAMONTSET2	940	60	MEGAL 2M
MEGAMONTSET4	940	220	MEGAL 4M
	500	220	MEGAL 4S

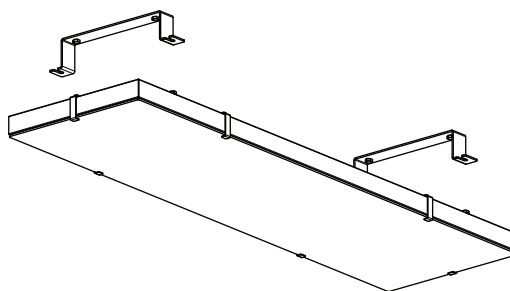
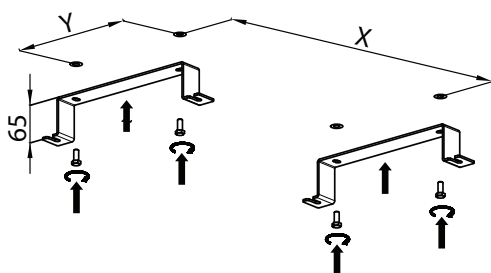

MEGALVESTRAM

Rám pro vestavbu svítidel MEGAL 4S do podhledu
Bíle lakovaný ocelový plech

MEGALVESTRAM

Frame for recessed installation of MEGAL 4S into a ceiling
White painted metal sheet

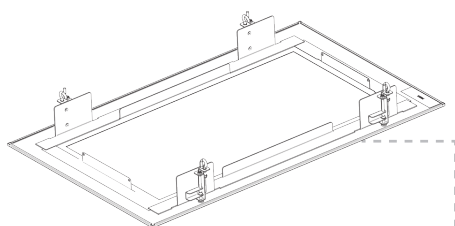

MEGALVESTRAM

	A	B	C	
MEGALVESTRAM/4S	800	500	110	670X470

MEGALPIR

Mikrovlnný senzor pro připojení ke svítidlům MEGAL a OKTA
Detekce pohybu a úrovně denního světla – funkce úplného vypnutí
svítidla při dostatečném denním osvětlení.

Krytí IP65

Sada vč. držáku a připojovacích kabelů s konektory IP65

Nastavení pomocí dálkového ovladače MEGALPIR/RC nebo pomocí
přepínačů na senzoru.

Varianty:

MEGALPIR/2M

MEGALPIR/4M

OKTAPIR

MEGALPIR

Microwave sensor for MEGAL and OKTA

This sensor is a motion switch, which turns on the light on detection of
people movement, and turns off after a pre-selected hold-time when
there is no people around. A daylight sensor is also built-in to prevent
the light switching on when there is sufficient natural light.

IP65

Set included assembly holder and cables with connectors

Settings after installation with remote controller MEGALPIR/RC or with DIP
switches.

Variants:

MEGALPIR/2M

MEGALPIR/4M

OKTAPIR

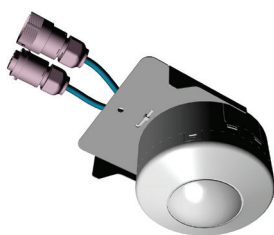

MEGALPIR

