

PCA TC ECO xitec II, 11 – 57 W ECO compact

Product description

- Processor-controlled ballast with xitec II inside
- Highest possible energy class CELMA EEI = A1 BAT[®]
- Noise-free precise control via DALI or DSI signal, switchDIM or corridorFUNCTION
- Nominal life up to 100,000 h (at ta 50 °C with a failure rate max. 0.2 % per 1,000 h)
- OEM-specific reserved memory areas
- 5-year guarantee

Interfaces

- DALI
- DSI
- switchDIM (with memory function + selectable dimming rate)
- corridorFUNCTION (3 preprogrammed profiles)
- Integrated SMART interface for function with SMART Sensor 5D 19f and corridorFUNCTION plugs

Functions

- Intelligent Temperature Guard (overtemperature protection)
- Intelligent Voltage Guard (overvoltage indication and undervoltage shutdown)
- Optimum filament heating in any dimmer setting
- Disconnection of filament heating from a dimming level of approx. 90 % for maximum energy efficiency (SMART-Heating concept)
- corridorFUNCTION with ambient light control
- Automatically triggered emergency lighting value in DC mode, 15 %
- For emergency lighting systems as per EN 50172
- Automatic start after replacement of defective lamps
- Automatic shutdown if the lamp is faulty

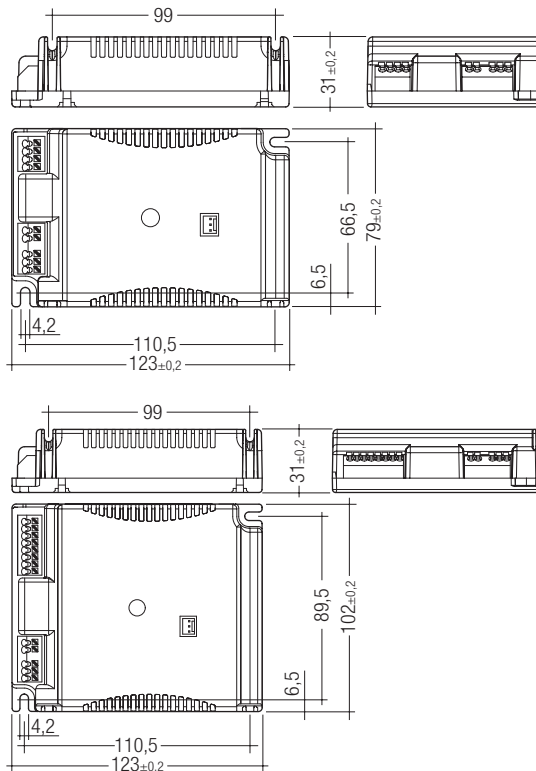

Technical data

Mains voltage range	220 – 240 V
AC voltage range	198 – 264 V
DC voltage range	176 – 280 V (lamp start ≥ 198 V DC)
Mains frequency	0 / 50 / 60 Hz
Overvoltage protection	320 V AC, 1 h
Typ. power input on standby	< 0.2 W
Protective hot restart	0.5 s for AC / 0.2 s for DC
Dimming range	3 – 100 %
Lamp start possible from	3 %
Operating frequency	~ 40 – 130 kHz
Type of protection	IP20



Standards, page 3

Wiring diagrams and installation examples, page 8

Ordering data

Type	Article number	Packaging, carton	Packaging, pallet	Weight per pc.
For luminaires with 1 lamp				
PCA 1x11/13 TC ECO xitec II	22185126	10 pc(s).	500 pc(s).	0.145 kg
PCA 1x18 TC ECO xitec II	22185122	10 pc(s).	500 pc(s).	0.147 kg
PCA 1x18/24 TCL ECO c xitec II	22185252	10 pc(s).	500 pc(s).	0.147 kg
PCA 1x26-57 TC ECO xitec II	22185120	10 pc(s).	500 pc(s).	0.163 kg
PCA 1x28 TC-DD ECO xitec II	22185255	10 pc(s).	500 pc(s).	0.147 kg
PCA 1x55 T5c ECO xitec II	22185124	10 pc(s).	500 pc(s).	0.163 kg
For luminaires with 2 lamps				
PCA 2x11/13 TC ECO xitec II	22185127	10 pc(s).	500 pc(s).	0.201 kg
PCA 2x18 TC ECO xitec II	22185123	10 pc(s).	500 pc(s).	0.202 kg
PCA 2x18/24 TCL ECO c xitec II	22185258	10 pc(s).	500 pc(s).	0.203 kg
PCA 2x26/32/42 TC ECO xitec II	22185121	10 pc(s).	500 pc(s).	0.205 kg

Specific technical data

Lamp wattage	Lamp type	Type	Article number	Dimensions L x W x H	Lamp power ^①	Circuit power ^②	EEL	Current at 50 Hz 230 V ^③	λ at 50 Hz 230 V	tc point max.	Ambient temperature ta ^③
For luminaires with 1 lamp											
1 x 11 W	TC-SEL	PCA 1x11/13 TC ECO xitec II	22185126	123 x 79 x 31 mm	11.0 W	12.5 W	A1	0.06 A	0.96	75 °C	-25 ... 70 °C
1 x 11 W	TC-TEL HE	PCA 1x11/13 TC ECO xitec II	22185126	123 x 79 x 31 mm	11.5 W	13.0 W	A1	0.07 A	0.96	75 °C	-25 ... 70 °C
1 x 13 W	TC-DEL	PCA 1x11/13 TC ECO xitec II	22185126	123 x 79 x 31 mm	12.5 W	13.5 W	A1 BAT	0.07 A	0.96	75 °C	-25 ... 70 °C
1 x 13 W	TC-TEL	PCA 1x11/13 TC ECO xitec II	22185126	123 x 79 x 31 mm	12.5 W	14.0 W	A1 BAT	0.07 A	0.96	75 °C	-25 ... 70 °C
1 x 14 W	TC-TEL HE	PCA 1x11/13 TC ECO xitec II	22185126	123 x 79 x 31 mm	14.5 W	16.0 W	A1 BAT	0.08 A	0.97	75 °C	-25 ... 70 °C
1 x 17 W	TC-TEL HE	PCA 1x11/13 TC ECO xitec II	22185126	123 x 79 x 31 mm	17.5 W	19.0 W	A1 BAT	0.09 A	0.98	75 °C	-25 ... 70 °C
1 x 18 W	TC-DEL	PCA 1x18 TC ECO xitec II	22185122	123 x 79 x 31 mm	16.5 W	19.0 W	A1 BAT	0.09 A	0.95	80 °C	-25 ... 70 °C
1 x 18 W	TC-TEL	PCA 1x18 TC ECO xitec II	22185122	123 x 79 x 31 mm	16.5 W	18.5 W	A1 BAT	0.09 A	0.95	80 °C	-25 ... 70 °C
1 x 18 W	TC-F	PCA 1x18/24 TCL ECO c xitec II	22185252	123 x 79 x 31 mm	15.0 W	18.5 W	A1 BAT	0.08 A	0.96	75 °C	-25 ... 65 °C
1 x 18 W	TC-L	PCA 1x18/24 TCL ECO c xitec II	22185252	123 x 79 x 31 mm	16.0 W	18.5 W	A1 BAT	0.08 A	0.96	75 °C	-25 ... 65 °C
1 x 22 W	T5c	PCA 1x18/24 TCL ECO c xitec II	22185252	123 x 79 x 31 mm	22.0 W	25.0 W	A1 BAT	0.11 A	0.98	75 °C	-25 ... 65 °C
1 x 24 W	TC-F	PCA 1x18/24 TCL ECO c xitec II	22185252	123 x 79 x 31 mm	20.0 W	24.5 W	A1 BAT	0.11 A	0.98	75 °C	-25 ... 65 °C
1 x 24 W	TC-L	PCA 1x18/24 TCL ECO c xitec II	22185252	123 x 79 x 31 mm	16.0 W	24.5 W	A1 BAT	0.12 A	0.98	75 °C	-25 ... 65 °C
1 x 26 W	TC-DEL	PCA 1x26-57 TC ECO xitec II	22185120	123 x 79 x 31 mm	24.0 W	26.5 W	A1 BAT	0.13 A	0.95	75 °C	-25 ... 65 °C
1 x 26 W	TC-TEL	PCA 1x26-57 TC ECO xitec II	22185120	123 x 79 x 31 mm	24.0 W	27.0 W	A1 BAT	0.13 A	0.95	75 °C	-25 ... 65 °C
1 x 32 W	TC-TEL	PCA 1x26-57 TC ECO xitec II	22185120	123 x 79 x 31 mm	32.0 W	35.0 W	A1 BAT	0.15 A	0.96	75 °C	-25 ... 65 °C
1 x 40 W	T5c	PCA 1x26-57 TC ECO xitec II	22185120	123 x 79 x 31 mm	40.0 W	43.0 W	A1 BAT	0.16 A	0.97	75 °C	-25 ... 65 °C
1 x 40 W	TC-L	PCA 1x26-57 TC ECO xitec II	22185120	123 x 79 x 31 mm	40.0 W	43.0 W	A1 BAT	0.18 A	0.97	75 °C	-25 ... 65 °C
1 x 42 W	TC-TEL	PCA 1x26-57 TC ECO xitec II	22185120	123 x 79 x 31 mm	42.0 W	44.0 W	A1 BAT	0.20 A	0.98	75 °C	-25 ... 65 °C
1 x 57 W	TC-TEL	PCA 1x26-57 TC ECO xitec II	22185120	123 x 79 x 31 mm	57.0 W	61.0 W	A1 BAT	0.24 A	0.98	75 °C	-25 ... 65 °C
1 x 28 W	TC-DD	PCA 1x28 TC-DD ECO xitec II	22185255	123 x 79 x 31 mm	26.5 W	27.5 W	A1 BAT	0.13 A	0.98	75 °C	-25 ... 65 °C
1 x 55 W	T5c	PCA 1x55 T5c ECO xitec II	22185124	123 x 79 x 31 mm	55.0 W	59.0 W	A1 BAT	0.26 A	0.98	70 °C	-25 ... 55 °C
For luminaires with 2 lamps											
2 x 11 W	TC-SEL	PCA 2x11/13 TC ECO xitec II	22185127	123 x 102 x 31 mm	22.0 W	24.5 W	A1 BAT	0.11 A	0.96	70 °C	-25 ... 60 °C
2 x 11 W	TC-TEL HE	PCA 2x11/13 TC ECO xitec II	22185127	123 x 102 x 31 mm	23.5 W	26.0 W	A1 BAT	0.12 A	0.96	70 °C	-25 ... 60 °C
2 x 13 W	TC-DEL	PCA 2x11/13 TC ECO xitec II	22185127	123 x 102 x 31 mm	25.0 W	27.0 W	A1 BAT	0.12 A	0.96	70 °C	-25 ... 60 °C
2 x 13 W	TC-TEL	PCA 2x11/13 TC ECO xitec II	22185127	123 x 102 x 31 mm	25.0 W	27.5 W	A1 BAT	0.12 A	0.96	70 °C	-25 ... 60 °C
2 x 14 W	TC-TEL HE	PCA 2x11/13 TC ECO xitec II	22185127	123 x 102 x 31 mm	29.0 W	31.0 W	A1 BAT	0.15 A	0.97	70 °C	-25 ... 60 °C
2 x 17 W	TC-TEL HE	PCA 2x11/13 TC ECO xitec II	22185127	123 x 102 x 31 mm	35.0 W	37.5 W	A1 BAT	0.17 A	0.98	70 °C	-25 ... 60 °C
2 x 18 W	TC-DEL	PCA 2x18 TC ECO xitec II	22185123	123 x 102 x 31 mm	33.0 W	36.0 W	A1 BAT	0.17 A	0.97	75 °C	-25 ... 70 °C
2 x 18 W	TC-TEL	PCA 2x18 TC ECO xitec II	22185123	123 x 102 x 31 mm	33.0 W	36.0 W	A1 BAT	0.17 A	0.97	75 °C	-25 ... 70 °C
2 x 18 W	TC-F	PCA 2x18/24 TCL ECO c xitec II	22185258	123 x 102 x 31 mm	15.0 W	37.0 W	A1 BAT	0.15 A	0.96	75 °C	-25 ... 60 °C
2 x 18 W	TC-L	PCA 2x18/24 TCL ECO c xitec II	22185258	123 x 102 x 31 mm	16.0 W	37.0 W	A1 BAT	0.16 A	0.97	75 °C	-25 ... 60 °C
2 x 24 W	TC-F	PCA 2x18/24 TCL ECO c xitec II	22185258	123 x 102 x 31 mm	20.0 W	48.0 W	A1 BAT	0.21 A	0.98	75 °C	-25 ... 60 °C
2 x 24 W	TC-L	PCA 2x18/24 TCL ECO c xitec II	22185258	123 x 102 x 31 mm	22.0 W	48.0 W	A1 BAT	0.22 A	0.98	75 °C	-25 ... 60 °C
2 x 26 W	TC-DEL	PCA 2x26/32/42 TC ECO xitec II	22185121	123 x 102 x 31 mm	48.0 W	52.0 W	A1 BAT	0.24 A	0.96	75 °C	-25 ... 60 °C
2 x 26 W	TC-TEL	PCA 2x26/32/42 TC ECO xitec II	22185121	123 x 102 x 31 mm	48.0 W	52.0 W	A1 BAT	0.24 A	0.96	75 °C	-25 ... 60 °C
2 x 32 W	TC-TEL	PCA 2x26/32/42 TC ECO xitec II	22185121	123 x 102 x 31 mm	64.0 W	68.0 W	A1 BAT	0.29 A	0.97	75 °C	-25 ... 60 °C
2 x 42 W	TC-TEL	PCA 2x26/32/42 TC ECO xitec II	22185121	123 x 102 x 31 mm	84.0 W	88.5 W	A1 BAT	0.39 A	0.98	75 °C	-25 ... 60 °C

① According to the EU directives on ecodesign requirements (EC) No. 245/2009 and (EC) No. 347/2010.

② Valid at 100 % dimming level.

③ +10 °C to ta max: unrestricted dimming. -25 °C to +10 °C: unrestricted dimming from 100 % to 30 %.

-25 °C to +10 °C, dimming below 30 %: malfunction possible but no damage to ECG. This applies to AC and DC operation.

Standards

EN 55015
EN 60929
EN 61000-3-2
EN 61347-2-3
EN 61547
Suitable for emergency installations according to EN 50172
CISPR 15
CISPR 22
IEC 60929
IEC 61000-3-2
IEC 61347-2-3
IEC 61547
IEC 62386 (according to DALi standard V1)

Lamp starting characteristics

Warm start
Starting time 0.5 s with AC
Starting time 0.2 s with DC
Start at any dimming level

AC operation

Mains voltage
220–240 V 50/60 Hz
198–264 V 50/60 Hz including safety tolerance ($\pm 10\%$)
198–254 V 50/60 Hz including performance tolerance (+6% / -8%)

DC operation

220–240 V 0 Hz
198–254 V 0 Hz certain lamp start
176–280 V 0 Hz operating range
Use in emergency lighting installations according to EN 50172 or for emergency luminaires according to EN 61347-2-3 appendix J.

Light output level in DC operation

Default value is 15%.
EBLF = 0.5 x adjusted DC dimming level
(e.g. 0.5 x 0.7).

Emergency units

The "PCA TC ECO xtec II" ballasts are compatible with all emergency units from Tridonic. See the table in the data sheet. Also all "5-pole" emergency units can be used. When used with other emergency units tests are necessary.

Temperature range

Unlimited dimming range from 10 °C bis t_a max.
-25 °C bis 10 °C: unlimited dimming from 100% to 30%.
-25 °C bis 10 °C, dimming below 30%:
malfunction possible, but no electronic ballast damage.
This applies to AC and DC operation.

Mains currents in DC operation (at 15% light output)

Type	Lamp type	Wattage	Mains current at	
			$U_n = 220 V_{oc}$	$U_n = 275 V_{oc}$
PCA 1x11/13 TC ECO xtec II	TC-SEL	1 x 11 W	0.04 A	0.03 A
	TC-TEL HE	1 x 11 W	0.04 A	0.03 A
	TC-DEL	1 x 13 W	0.04 A	0.03 A
	TC-TEL	1 x 13 W	0.04 A	0.03 A
	TC-TEL HE	1 x 14 W	0.04 A	0.04 A
PCA 1x18 TC ECO xtec II	TC-TEL HE	1 x 17 W	0.04 A	0.04 A
	TC-DEL	1 x 18 W	0.05 A	0.04 A
	TC-TEL	1 x 18 W	0.04 A	0.04 A
PCA 1x18/24 TCL ECO c xtec II	TC-F	1 x 18 W	0.04 A	0.04 A
	TC-L	1 x 18 W	0.04 A	0.04 A
	T5c	1 x 22 W	0.06 A	0.05 A
	TC-F	1 x 24 W	0.05 A	0.04 A
PCA 1x26-57 TC ECO xtec II	TC-L	1 x 24 W	0.05 A	0.05 A
	TC-DEL	1 x 26 W	0.06 A	0.05 A
	TC-TEL	1 x 26 W	0.06 A	0.05 A
	TC-TEL	1 x 32 W	0.06 A	0.06 A
PCA 1x28 TC-DD ECO xtec II	T5c	1 x 40 W	0.07 A	0.06 A
	TC-L	1 x 40 W	0.07 A	0.07 A
	TC-TEL	1 x 42 W	0.07 A	0.07 A
PCA 1x55 T5c ECO xtec II	TC-TEL	1 x 57 W	0.09 A	0.08 A
	TC-DD	1 x 28 W	0.06 A	0.05 A
	T5c	1 x 55 W	0.10 A	0.09 A
PCA 2x11/13 TC ECO xtec II	TC-SEL	2 x 11 W	0.05 A	0.05 A
	TC-TEL HE	2 x 11 W	0.06 A	0.05 A
	TC-DEL	2 x 13 W	0.06 A	0.05 A
	TC-TEL	2 x 13 W	0.06 A	0.05 A
	TC-TEL HE	2 x 14 W	0.06 A	0.06 A
PCA 2x18 TC ECO xtec II	TC-TEL HE	2 x 17 W	0.07 A	0.06 A
	TC-DEL	2 x 18 W	0.07 A	0.07 A
	TC-TEL	2 x 18 W	0.07 A	0.06 A
PCA 2x18/24 TCL ECO c xtec II	TC-F	2 x 18 W	0.07 A	0.05 A
	TC-L	2 x 18 W	0.07 A	0.06 A
	TC-F	2 x 24 W	0.09 A	0.07 A
	TC-L	2 x 24 W	0.04 A	0.07 A
PCA 2x26/32/42 TC ECO xtec II	TC-DEL	2 x 26 W	0.12 A	0.09 A
	TC-TEL	2 x 26 W	0.10 A	0.09 A
	TC-TEL	2 x 32 W	0.11 A	0.10 A
	TC-TEL	2 x 42 W	0.12 A	0.11 A

Ballast lumen factor AC operation (AC-BLF) EN 60929 8.1

Type	Lamp type	Wattage	AC-BLF at U = 230 V _{AC}
PCA 1x11/13 TC ECO x ₁ tec II	TC-SEL	1 x 11 W	1.04
	TC-TEL HE	1 x 11 W	1.05
	TC-DEL	1 x 13 W	1.00
	TC-TEL	1 x 13 W	0.99
	TC-TEL HE	1 x 14 W	1.05
	TC-TEL HE	1 x 17 W	1.06
PCA 1x18 TC ECO x ₁ tec II	TC-DEL	1 x 18 W	1.02
	TC-TEL	1 x 18 W	1.03
PCA 1x18/24 TCL ECO c x ₁ tec II	TC-F	1 x 18 W	0.97
	TC-L	1 x 18 W	0.97
	T5c	1 x 22 W	1.03
	TC-F	1 x 24 W	1.03
	TC-L	1 x 24 W	1.03
PCA 1x26-57 TC ECO x ₁ tec II	TC-DEL	1 x 26 W	1.00
	TC-TEL	1 x 26 W	1.02
	TC-TEL	1 x 32 W	0.98
	T5c	1 x 40 W	0.96
	TC-L	1 x 40 W	0.96
	TC-TEL	1 x 42 W	1.00
PCA 1x28 TC-DD ECO x ₁ tec II	TC-TEL	1 x 57 W	0.98
	TC-DD	1 x 28 W	1.01
PCA 1x55 T5c ECO x ₁ tec II	T5c	1 x 55 W	1.00
PCA 2x11/13 TC ECO x ₁ tec II	TC-SEL	2 x 11 W	1.04
	TC-TEL HE	2 x 11 W	1.04
	TC-DEL	2 x 13 W	0.99
	TC-TEL	2 x 13 W	0.98
	TC-TEL HE	2 x 14 W	1.04
	TC-TEL HE	2 x 17 W	1.04
PCA 2x18 TC ECO x ₁ tec II	TC-DEL	2 x 18 W	1.01
	TC-TEL	2 x 18 W	1.03
PCA 2x18/24 TCL ECO c x ₁ tec II	TC-F	2 x 18 W	0.94
	TC-L	2 x 18 W	0.94
	TC-F	2 x 24 W	1.03
	TC-L	2 x 24 W	1.03
PCA 2x26/32/42 TC ECO x ₁ tec II	TC-DEL	2 x 26 W	1.00
	TC-TEL	2 x 26 W	1.01
	TC-TEL	2 x 32 W	0.97
	TC-TEL	2 x 42 W	0.99

The ballast lumen factor for AC operation (AC-BLF) does not alter from U_n = 198 V_{AC} to U_n = 254 V_{AC}.
The ballast lumen factor for DC operation (DC-BLF) on the basis of an automatic power reduction of the ballasts (default value is 15%) will be smaller than AC. It does not alter in the DC operating range (198–264 V_{DC}).

Dimming

Dimming curve is adapted to the eye sensitiveness.

Dimming range 3 % to 100 %

Digital control with:

- DSI signal: 8 bit Manchester Code
Speed 3 % to 100 % in 1,16 s
- DALI signal: 16 bit Manchester Code
Maximum speed 3 % to 100 % in 550 ms
(adjustable between 100 ms and 90 s)
Programmable parameter:
Minimum dimming level
Maximum dimming level
Default minimum = 3 %
Default maximum = 100 %

Control input (DA/D1, DA/D2)

Digital DSI signal, push-to-make switch (switchDIM) or the digital control signal DALI/DSI can be wired on the same terminals (DA/D1 and DA/D2).

Digital signal DALI/DSI

The control input is non-polar and protected against accidental connection with a mains voltage up to 264 V. The control signal is not SELV. Control cable has to be installed in accordance to the requirements of low voltage installations.

Different functions depending on each module.

SMART interface

An additional interface for the direct connection of the SMART-Sensor 5D 19f¹⁾ or corridorFUNCTION plugs. Application and functionality see corridorFUNCTION user manual.

SMART-Sensor 5D 19f¹⁾ light sensor operating mode: The sensor registers actual ambient light and maintains the individually defined constant lux level.

After every mains reset the SMART interface automatically checks for an installed sensor. With the sensor installed the PCA TC ECO xtec II automatically runs in the constant lux level mode. ON/OFF switch via mains, switchDIM or DSI signal.

DSI signal = 0 switches off,

DSI signal ≥ 1 switches on.

With switchDIM signals it is possible to change the controlled light level temporarily.

Temporarily means that after a switching cycle OFF/ON command the ballast will start at the preset value determined by the SMART-Sensor 5D 19f. The installation of the two wire bus is according to the appropriate low voltage regulations.

¹⁾ Light sensor 5D: article number 86459169

switchDIM

Integrated switchDIM function allows a direct connection of a push to make switch for dimming and switching.

Brief push (< 0.6 s) switches ballast ON and OFF. The ballasts switch-ON at light level set at switch-OFF. After switch ON the last setted dimming level will be activated again.

When the push to make switch is held, PCA ballasts are dimmed. After repush the PCA is dimmed in the opposite direction.

The switchDIM fade time is set to 3 s from min. to max. in the factory settings. With a 20 s push to the push to make switch this fade time can be changed to 6 s. In this instance the switchDIM application will be synchronized to 50 % light level after 10 s and after 20 s the light level rises to 100 % with the new fade time.

Dimming characteristics PCA TC ECO xtec II

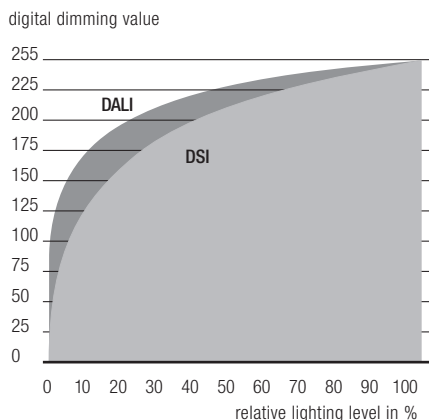

Dimming characteristics as seen by the human eye

Energy saving PCA TC ECO xtec II

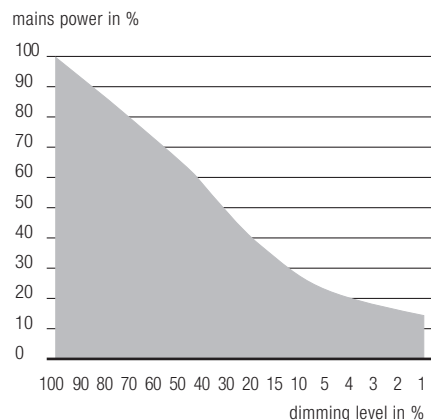

At every synchronisation (10 s keystroke) the device will reset to 3 s (factory setting) In installations with PCAs with different dimming levels or opposite dimming directions (e.g. after a system extension), all PCAs can be synchronized to 50 % dimming level by a 10 s push.

Use of push to make switch with indicator lamp is not permitted.

switchDIM and corridorFUNCTION are very simple tools for controlling ballasts with conventional momentary-action switches or motion sensors. To ensure correct operation a sinusoidal mains voltage with a frequency of 50 Hz or 60 Hz is required at the control input. Special attention must be paid to achieving clear zero crossings. Serious mains faults may impair the operation of switchDIM and corridorFUNCTION.

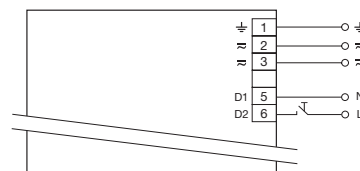

switchDIM PCA TC ECO xtec II

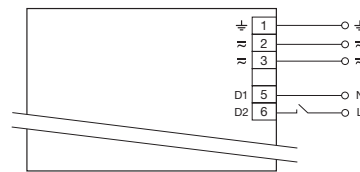

corridorFUNCTION PCA TC ECO xtec II

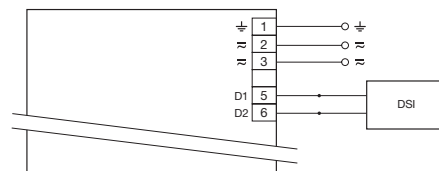

DSI PCA TC ECO xtec II

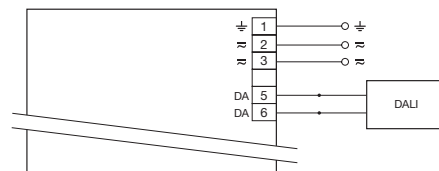

DALI PCA TC ECO xtec II

corridorFUNCTION

To activate the corridorFUNCTION a voltage of 230 V simply has to be applied for five minutes at switchDIM connection. The unit will then switch automatically to the corridorFUNCTION.

Note: If the corridorFUNCTION is wrongly activated in a switchDIM system (for example a switch is used instead of pushbutton), there is the option of installing a pushbutton and deactivating the corridorFUNCTION mode by five short pushes of the button within three seconds.

The corridorFUNCTION offers the added benefit of a second and third preprogrammed profile, which can be activated by the corridorFUNCTION plugs. It is also possible to combine the corridorFUNCTION with the SMART-Sensor 5D 19f light sensor.

Application and functionality of profiles see user manual of the corridorFUNCTION.

Loading of automatic circuit breakers (Limitation via inrush current)

Automatic circuit breaker type	C10		C13		C16		C20		B10		B13		B16		B20		Inrush current (1.5 mm ²)		Inrush current (2.5 mm ²)	
	Installation Ø	1.5 mm ²	1.5 mm ²	1.5 mm ²	2.5 mm ²	1.5 mm ²	1.5 mm ²	1.5 mm ²	1.5 mm ²	1.5 mm ²	1.5 mm ²	1.5 mm ²	1.5 mm ²	2.5 mm ²	I _{max}	time	I _{max}	time		
PCA 1x11/13 TC ECO xitec II	50	84	210	230	25	42	105	115	21.7 A	152 µs	21.3 A	157 µs								
PCA 1x18 TC ECO xitec II	44	76	80	80	22	38	40	40	24.6 A	147 µs	24.5 A	150 µs								
PCA 1x18/24 TCL ECO c xitec II	50	82	110	137	25	41	110	116	14.7 A	206 µs	15.6 A	199 µs								
PCA 1x26-57 TC ECO xitec II	22	32	46	52	11	16	23	26	27.7 A	232 µs	30.4 A	213 µs								
PCA 1x28 TC-DD ECO xitec II	50	84	105	132	25	42	105	118	16.4 A	189 µs	18.8 A	172 µs								
PCA 1x55 T5c ECO xitec II	22	32	44	50	11	16	22	25	26.8 A	240 µs	27.5 A	235 µs								
PCA 2x11/13 TC ECO xitec II	34	50	76	84	17	25	38	42	23.0 A	189 µs	23.7 A	186 µs								
PCA 2x18 TC ECO xitec II	32	50	76	80	16	25	38	40	24.5 A	181 µs	29.7 A	145 µs								
PCA 2x18/24 TCL ECO c xitec II	20	30	42	48	10	15	21	24	25.2 A	255 µs	27.2 A	245 µs								
PCA 2x26/32/42 TC ECO xitec II	14	20	28	32	7	10	14	16	34.2 A	248 µs	36.4 A	242 µs								

Continuous operation: to calculate the protective safety switch see main current, page 2

Intelligent Voltage Guard

Intelligent Voltage Guard is the name of the electronic monitor from Tridonic. This innovative feature of the PCA family of control gear from Tridonic immediately shows if the mains voltage rises above certain thresholds. Measures can then be taken quickly to prevent damage to the control gear.

- If the mains voltage rises above approx. 318 V_{rms} (voltage depends on the ballast type), the lamp starts flashing on and off.
- To avoid a damage of the device the mains supply has to be switched off at this signal.

Intelligent Temperature Guard

The intelligent temperature guard protects the PCA TC ECO xitec II from thermal overheating by reducing the output power or switching off in case of operation above the thermal limits of the luminaire or ballast. Depending on the luminaire design, the ITG operates at about 5 to 10 °C above tc temperature.

Harmonic distortion in the mains supply (at 230V/50 Hz)

Type	Lamp type	Wattage	THD	3	5	7	9	11
PCA 1x11/13 TC ECO xitec II	TC-SEL	1x11 W	10	4	3	2	2	2
	TC-TEL HE	1x11 W	10	4	2	2	2	2
	TC-DEL	1x13 W	10	4	3	2	2	2
	TC-TEL	1x13 W	10	4	3	2	2	2
	TC-TEL HE	1x14 W	9	5	2	1	1	1
	TC-TEL HE	1x17 W	8	5	1	1	1	1
PCA 1x18 TC ECO xitec II	TC-DEL	1x18 W	9	7	1	2	2	2
	TC-DEL	1x18 W	9	7	2	2	2	2
	TC-F	1x18 W	10	4	2	2	2	2
	TC-L	1x18 W	9	4	2	2	2	2
PCA 1x18/24 TCL ECO c xitec II	T5c	1x22 W	8	4	1	1	1	1
	TC-F	1x24 W	8	4	1	1	1	1
	TC-L	1x24 W	7	4	1	1	1	1
	TC-DEL	1x26 W	10	6	3	3	3	3
PCA 1x26-57 TC ECO xitec II	TC-TEL	1x26 W	10	5	2	3	2	2
	TC-TEL	1x32 W	9	6	2	2	2	2
	T5c	1x40 W	9	6	2	2	2	2
	TC-L	1x40 W	9	6	2	1	2	2
	TC-TEL	1x42 W	7	5	2	1	1	1
	TC-TEL	1x57 W	7	6	1	1	1	1
PCA 1x28 TC-DD ECO xitec II	TC-DD	1x28 W	9	6	2	1	1	1
PCA 1x55 T5c ECO xitec II	T5c	1x55 W	8	4	2	2	2	1
PCA 2x11/13 TC ECO xitec II	TC-SEL	2x11 W	10	4	4	2	2	2
	TC-TEL HE	2x11 W	10	4	4	2	2	2
	TC-DEL	2x13 W	10	4	4	2	2	2
	TC-TEL	2x13 W	10	4	4	3	2	2
	TC-TEL HE	2x14 W	8	4	3	2	2	1
	TC-TEL HE	2x17 W	8	5	2	1	1	1
PCA 2x18 TC ECO xitec II	TC-DEL	2x18 W	9	6	2	1	1	1
	TC-TEL	2x18 W	9	6	1	1	1	1
	TC-F	2x18 W	9	5	1	2	2	2
PCA 2x18/24 TCL ECO c xitec II	TC-L	2x18 W	9	5	1	1	2	2
	TC-F	2x24 W	7	5	1	1	1	1
	TC-L	2x24 W	7	5	1	1	1	1
	TC-DEL	2x26 W	10	6	3	3	2	2
PCA 2x26/32/42 TC ECO xitec II	TC-TEL	2x26 W	10	7	2	2	2	2
	TC-TEL	2x32 W	9	7	2	2	2	2
	TC-TEL	2x42 W	8	7	1	1	1	1

Operating voltage

Type	Lamp type	Wattage	U _{out}
PCA 1x11/13 TC ECO xrttec II	TC-SEL	1x11 W	430 V
	TC-TEL HE	1x11 W	430 V
	TC-DEL	1x13 W	430 V
	TC-TEL	1x13 W	430 V
	TC-TEL HE	1x14 W	430 V
	TC-TEL HE	1x17 W	430 V
PCA 1x18 TC ECO xrttec II	TC-DEL	1x18 W	430 V
	TC-TEL	1x18 W	430 V
PCA 1x18/24 TCL ECO c xrttec II	TC-F	1x18 W	430 V
	TC-L	1x18 W	430 V
	T5c	1x22 W	430 V
	TC-F	1x24 W	430 V
PCA 1x26-57 TC ECO xrttec II	TC-L	1x24 W	430 V
	TC-DEL	1x26 W	430 V
	TC-TEL	1x26 W	430 V
	TC-TEL	1x32 W	430 V
	T5c	1x40 W	430 V
	TC-L	1x40 W	430 V
PCA 1x28 TC-DD ECO xrttec II	TC-TEL	1x42 W	430 V
	TC-TEL	1x57 W	430 V
	TC-DD	1x28 W	430 V
	TC-DD	1x28 W	430 V
PCA 1x55 T5c ECO xrttec II	T5c	1x55 W	430 V
PCA 2x11/13 TC ECO xrttec II	TC-SEL	2x11 W	430 V
	TC-TEL HE	2x11 W	430 V
	TC-DEL	2x13 W	430 V
	TC-TEL	2x13 W	430 V
	TC-TEL HE	2x14 W	430 V
	TC-TEL HE	2x17 W	430 V
PCA 2x18 TC ECO xrttec II	TC-DEL	2x18 W	430 V
	TC-TEL	2x18 W	430 V
PCA 2x18/24 TCL ECO c xrttec II	TC-F	2x18 W	430 V
	TC-L	2x18 W	430 V
	TC-F	2x24 W	430 V
	TC-L	2x24 W	430 V
PCA 2x26/32/42 TC ECO xrttec II	TC-DEL	2x26 W	430 V
	TC-TEL	2x26 W	430 V
	TC-TEL	2x32 W	430 V
	TC-TEL	2x42 W	430 V

Humidity: 5 % up to max. 85 %,
not condensed
(max. 56 days/year at 85 %)

Storage temperature: -40 °C up to max. +80 °C

The devices have to be within the specified temperature range (ta) before they can be operated.

Installation instructions

Wiring type and cross section

The wiring can be in stranded wires with ferrules or solid with a cross section of 0.5–1.5 mm².

Strip 9.5 mm of insulation from the cables to ensure perfect operation of the push-wire terminals.

wire preparation:
0.5 – 1.5 mm²

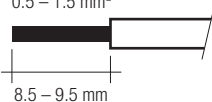

Release of the wiring

Press down the “push button” and remove the cable from front.

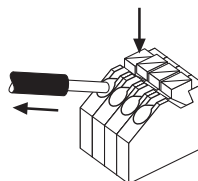

Mounting of device

Max. torque for fixing: 0.5 Nm/M4

Expected life-time

Type	Lamp type	Wattage		ta = 40 °C	ta = 50 °C	ta = 60 °C
PCA 1x11/13 TC ECO xrtec II	TC-SEL	1 x 11 W	tc	45 °C	55 °C	65 °C
			Life-time	> 100,000 h	> 100,000 h	> 100,000 h
	TC-TEL HE	1 x 11 W	tc	45 °C	55 °C	65 °C
			Life-time	> 100,000 h	> 100,000 h	> 100,000 h
	TC-DEL	1 x 13 W	tc	45 °C	55 °C	65 °C
			Life-time	> 100,000 h	> 100,000 h	> 100,000 h
TC-TEL	1 x 13 W	tc	45 °C	55 °C	65 °C	
		Life-time	> 100,000 h	> 100,000 h	> 100,000 h	
PCA 1x18 TC ECO xrtec II	TC-TEL HE	1 x 14 W	tc	45 °C	55 °C	65 °C
			Life-time	> 100,000 h	> 100,000 h	> 100,000 h
	TC-TEL HE	1 x 17 W	tc	45 °C	55 °C	65 °C
			Life-time	> 100,000 h	> 100,000 h	> 100,000 h
	TC-DEL	1 x 18 W	tc	50 °C	60 °C	70 °C
			Life-time	> 100,000 h	> 100,000 h	90,000 h
TC-TEL	1 x 18 W	tc	50 °C	60 °C	70 °C	
		Life-time	> 100,000 h	> 100,000 h	90,000 h	
PCA 1x18/24 TCL ECO c xrtec II	TC-F	1 x 18 W	tc	50 °C	60 °C	70 °C
			Life-time	> 100,000 h	> 100,000 h	90,000 h
	TC-L	1 x 18 W	tc	50 °C	60 °C	70 °C
			Life-time	> 100,000 h	> 100,000 h	90,000 h
	T5c	1 x 22 W	tc	50 °C	60 °C	70 °C
			Life-time	> 100,000 h	> 100,000 h	90,000 h
TC-F	1 x 24 W	tc	50 °C	60 °C	70 °C	
		Life-time	> 100,000 h	> 100,000 h	90,000 h	
TC-L	1 x 24 W	tc	50 °C	60 °C	70 °C	
		Life-time	> 100,000 h	> 100,000 h	90,000 h	

Expected life-time

Type	Lamp type	Wattage		ta = 40 °C	ta = 50 °C	ta = 60 °C
PCA 1x26-57 TC ECO xrttec II	TC-DEL	1 x 26 W	tc	55 °C	65 °C	75 °C
			Life-time	> 100,000 h	> 100,000 h	80,000 h
	TC-TEL	1 x 26 W	tc	55 °C	65 °C	75 °C
			Life-time	> 100,000 h	> 100,000 h	80,000 h
	TC-TEL	1 x 32 W	tc	55 °C	65 °C	75 °C
			Life-time	> 100,000 h	> 100,000 h	80,000 h
	T5c	1 x 40 W	tc	50 °C	60 °C	75 °C
			Life-time	> 100,000 h	> 100,000 h	75,000 h
	TC-L	1 x 40 W	tc	50 °C	60 °C	75 °C
			Life-time	> 100,000 h	> 100,000 h	75,000 h
	TC-TEL	1 x 42 W	tc	50 °C	60 °C	75 °C
			Life-time	> 100,000 h	> 100,000 h	75,000 h
TC-TEL	1 x 57 W	tc	50 °C	60 °C	70 °C	
		Life-time	> 100,000 h	> 100,000 h	> 100,000 h	
PCA 1x28 TC-DD ECO xrttec II	TC-DD	1 x 28 W	tc	50 °C	60 °C	70 °C
			Life-time	> 100,000 h	> 100,000 h	90,000 h
PCA 1x55 T5c ECO xrttec II	T5c	1 x 55 W	tc	55 °C	65 °C	x
			Life-time	> 100,000 h	> 100,000 h	x
PCA 2x11/13 TC ECO xrttec II	TC-SEL	2 x 11 W	tc	50 °C	60 °C	70 °C
			Life-time	> 100,000 h	> 100,000 h	> 100,000 h
	TC-TEL HE	2 x 11 W	tc	50 °C	60 °C	70 °C
			Life-time	> 100,000 h	> 100,000 h	> 100,000 h
	TC-DEL	2 x 13 W	tc	50 °C	60 °C	70 °C
			Life-time	> 100,000 h	> 100,000 h	> 100,000 h
	TC-TEL	2 x 13 W	tc	50 °C	60 °C	70 °C
			Life-time	> 100,000 h	> 100,000 h	> 100,000 h
	TC-TEL HE	2 x 14 W	tc	50 °C	60 °C	70 °C
			Life-time	> 100,000 h	> 100,000 h	> 100,000 h
	TC-TEL HE	2 x 17 W	tc	50 °C	60 °C	70 °C
			Life-time	> 100,000 h	> 100,000 h	> 100,000 h
PCA 2x18 TC ECO xrttec II	TC-DEL	2 x 18 W	tc	55 °C	60 °C	70 °C
			Life-time	> 100,000 h	> 100,000 h	> 100,000 h
	TC-TEL	2 x 18 W	tc	55 °C	60 °C	70 °C
			Life-time	> 100,000 h	> 100,000 h	> 100,000 h
PCA 2x18/24 TCL ECO c xrttec II	TC-F	2 x 18 W	tc	60 °C	65 °C	75 °C
			Life-time	> 100,000 h	> 100,000 h	50,000 h
	TC-L	2 x 18 W	tc	60 °C	65 °C	75 °C
			Life-time	> 100,000 h	> 100,000 h	50,000 h
	TC-F	2 x 24 W	tc	60 °C	65 °C	75 °C
			Life-time	> 100,000 h	> 100,000 h	50,000 h
TC-L	2 x 24 W	tc	60 °C	65 °C	75 °C	
		Life-time	> 100,000 h	> 100,000 h	50,000 h	
PCA 2x26/32/42 TC ECO xrttec II	TC-DEL	2 x 26 W	tc	60 °C	70 °C	75 °C
			Life-time	> 100,000 h	> 100,000 h	50,000 h
	TC-TEL	2 x 26 W	tc	60 °C	70 °C	75 °C
			Life-time	> 100,000 h	> 100,000 h	50,000 h
	TC-TEL	2 x 32 W	tc	60 °C	70 °C	75 °C
			Life-time	> 100,000 h	> 100,000 h	50,000 h
TC-TEL	2 x 42 W	tc	60 °C	65 °C	75 °C	
		Life-time	> 100,000 h	> 100,000 h	50,000 h	

x = not permitted

Wiring advice

The lead length is dependent on the capacitance of the cable.

Ballast Type	Terminal	Maximum capacitance allowed	
		Cold	Hot
PCA 1xx TC ECO x tec II	12, 13	10, 11	200 pF / 100 pF
PCA 2xx TC ECO x tec II	12, 13, 14, 15	10, 11, 16, 17	200 pF / 100 pF

With standard solid wire 0.5/0.75 mm² the capacitance of the lead is 30–80 pF/m.

This value is influenced by the way the wiring is made.

Lamp connection should be made with symmetrical wiring.

Hot leads (10, 11, 16, 17) and cold leads (12, 13, 14, 15) should be separated as much as possible.

When using two or more dimmable ballasts in one luminaire with separate dimming controls, the lamp leads must be kept separate.

Sensor wires

Sensor wires must be routed separately from the lamp wires and mains cables otherwise the lighting control system may malfunction. If separate routing is not possible (for reasons of space) shielded lamp wires and mains cables must be used.

Dimmable ballasts from Tridonic have to be earthed.

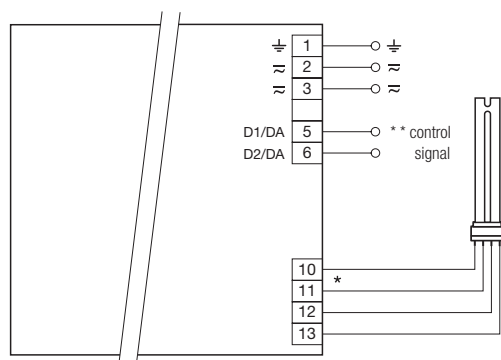

* leads 10, 11: keep wires short, max. 1.0 m
leads 12, 13 max. 2.0 m; ballast must be earthed
** digital signal DALI, DSI or switchDIM

PCA TC ECO x|tec II 1x18–57 W

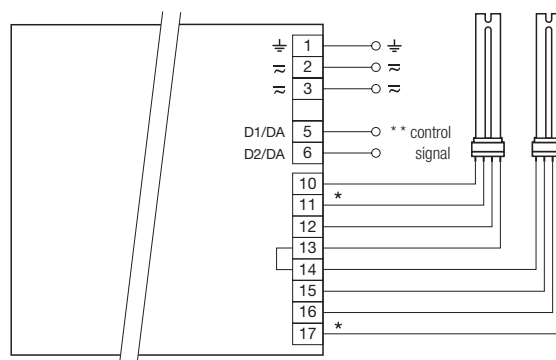

* leads 10, 11, 16, 17 keep wires short, max. 1.0 m
leads 12, 13, 14, 15 max. 2.0 m; EVG erden
** digital signal DALI, DSI or switchDIM

PCA TC ECO x|tec II 2x18–42 W

Dimmable ballasts from Tridonic have to be earthed.

RFI

- Connection to the lamps of the hot leads must be kept as short as possible
- Mains leads should be kept apart from lamp leads (ideally 5–10 cm distance)
- Do not run mains leads adjacent to the electronic ballast
- Twist the lamp leads
- Keep the distance of lamp leads from the metal work as large as possible
- Mains wiring to be twisted when through wiring
- Keep the mains leads inside the luminaire as short as possible

General advise

Electronic ballasts are virtually noise free.

Magnetic fields generated during the ignition cycle can cause some background noise but only for a few milliseconds.

Operation on DC voltage

Our ballasts are constructed to operate DC voltage and pulsed DC voltage.

To operate ballasts with pulsed DC voltage the polarity is absolute mandatory.

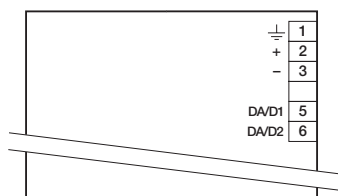

Isolation and electric strength testing of luminaires

Electronic devices can be damaged by high voltage. This has to be considered during the routine testing of the luminaires in production.

According to IEC 60598-1 Annex Q (informative only!) or ENEC 303-Annex A, each luminaire should be submitted to an isolation test with 500 Vdc for 1 second. This test voltage should be connected between the interconnected phase and neutral terminals and the earth terminal. The isolation resistance must be at least 2 MΩ.

As an alternative, IEC 60598-1 Annex Q describes a test of the electrical strength with 1500 VAC (or 1.414 x 1500 Vdc). To avoid damage to the electronic devices this test must not be conducted.

Glow-wire test according to EN 60598-1

650 °C, 750 °C and 850 °C passed

① For further technical information please visit www.tridonic.com