

## PCA T5 ECO Ip x:tec 14–80 W 220–240 V 50/60/0 Hz

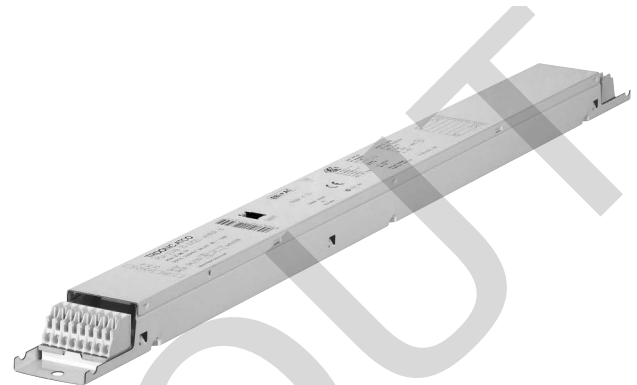
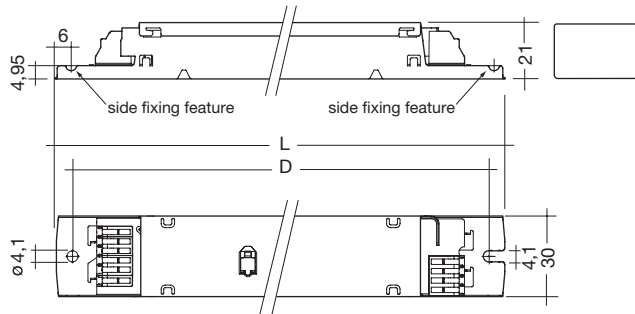

- world first: first processor-controlled ballast with x:tec inside
- operation of T5 lamps of the same length (e.g. FH 28 W / FQ 54 W)
- automatic lamp detection and operation with correct lamp parameters
- average service life = 50,000 h (at ta max. with a failure rate ≤ 0.2 % per 1,000 operating hours)
- dimming range from 1–100 %
- lamp friendly warm start within 0.5 s with AC and 0.2 s with DC
- power consumption in standby mode < 0.5 W
- disturbance free precise control with a digital DSI signal or switchDIM
- fully digital lamp management for flash-free starting at any dimming level
- operating frequency ~40–100 kHz
- integrated SMART interface
- Intelligent Voltage Guard (overvoltage indication and undervoltage protection)
- Intelligent Temperature Guard (overtemperature protection)
- automatically triggered emergency light value for DC and rectified AC voltage
- SMART Heating Concept for optimum filament heating at any dimming level and cut off the electrodes at approx. 90 % dimmlevel for maximum energy efficiency
- backwards compatibility adjustable
- corridorFUNCTION V2 with 3 profiles

**Packaging:**  
**360 mm housing**  
box of 10  
76 boxes/pallet  
760 pieces/pallet

**425 mm housing**  
box of 25  
33 boxes/pallet  
825 pieces/pallet

**Certified:**  
EN 55015  
EN 55022  
EN 60929  
EN 61000-3-2  
EN 61347-2-3  
EN 61547  
Suitable for emergency installations according to EN 50172

Lamp		Ballast										
wattage	type	type	article number	length L	fixing centres D	weight	circuit power W ②	lamp power W ②	current at 230 V / 50 Hz A ②	λ at 230 V / 50 Hz	tc point °C	temperature range °C ①
W				mm	mm	kg						
1x14	T5	PCA 1x14/24 T5 ECO Ip x:tec	22176247	360	350	0.25	16.0	1x14	0.08	0.95	80	-25 → +60
2x14	T5	PCA 2x14/24 T5 ECO Ip x:tec	22176248	360	350	0.28	32.5	2x14	0.15	0.97	80	-25 → +60
1x24	T5	PCA 1x14/24 T5 ECO Ip x:tec	22176247	360	350	0.25	25.5	1x24	0.12	0.97	80	-25 → +60
1x24	TC-L	PCA 1x14/24 T5 ECO Ip x:tec	22176247	360	350	0.25	25.5	1x24	0.12	0.97	80	-25 → +60
2x24	T5	PCA 2x14/24 T5 ECO Ip x:tec	22176248	360	350	0.28	51.0	2x24	0.23	0.98	85	-25 → +60
2x24	TC-L	PCA 2x14/24 T5 ECO Ip x:tec	22176248	360	350	0.28	51.0	2x24	0.23	0.98	85	-25 → +60
1x21	T5	PCA 1x21/39 T5 ECO Ip x:tec	22176245	360	350	0.25	23.5	1x21	0.11	0.95	85	-25 → +60
2x21	T5	PCA 2x21/39 T5 ECO Ip x:tec	22176246	425	415	0.35	45.5	2x21	0.21	0.97	80	-25 → +60
1x39	T5	PCA 1x21/39 T5 ECO Ip x:tec	22176245	360	350	0.25	42.0	1x39	0.20	0.97	85	-25 → +60
1x40	TC-L	PCA 1x21/39 T5 ECO Ip x:tec	22176245	360	350	0.25	42.0	1x39	0.19	0.97	80	-25 → +60
2x39	T5	PCA 2x21/39 T5 ECO Ip x:tec	22176246	425	415	0.35	82.5	2x39	0.38	0.99	85	-25 → +60
1x28	T5	PCA 1x28/54 T5 ECO Ip x:tec	22176243	360	350	0.26	30.5	1x28	0.15	0.95	80	-25 → +60
2x28	T5	PCA 2x28/54 T5 ECO Ip x:tec	22176244	425	415	0.35	60.5	2x28	0.28	0.97	80	-25 → +60
1x54	T5	PCA 1x28/54 T5 ECO Ip x:tec	22176243	360	350	0.26	59.5	1x54	0.27	0.98	85	-25 → +60
2x54	T5	PCA 2x28/54 T5 ECO Ip x:tec	22176244	425	415	0.35	116.5	2x54	0.53	0.99	85	-25 → +55
1x35	T5	PCA 1x35/49/80 T5 ECO Ip x:tec	22176241	360	350	0.27	38.5	1x35	0.18	0.97	80	-25 → +60
2x35	T5	PCA 2x35/49 T5 ECO Ip x:tec	22176242	425	415	0.34	75.0	2x35	0.33	0.97	80	-25 → +60
1x49	T5	PCA 1x35/49/80 T5 ECO Ip x:tec	22176241	360	350	0.27	53.0	1x49	0.24	0.97	80	-25 → +60
2x49	T5	PCA 2x35/49 T5 ECO Ip x:tec	22176242	425	415	0.34	105.5	2x49	0.47	0.98	85	-25 → +60
1x80	T5	PCA 1x35/49/80 T5 ECO Ip x:tec	22176241	360	350	0.37	86.5	1x80	0.39	0.98	85	-25 → +60
2x80	T5	PCA 2/80 T5 ECO Ip ③	22176054	425	415	0.35	164.5	2x80	0.75	0.99	80	-25 → +50

① 10 °C to ta max: normal diming operation

-25 °C to +10 °C: dimming operation from 100 % to 30 %.

-25 °C to +10 °C, dimming below 30 %: Ballast could shut down but will not cause failure. This applies to AC and DC operation.

② valid at 100 % light output

③ single wattage ballast, corridorFUNCTION V1, power consumption in standby mode <0.8W

**Lamp starting characteristics:**

Warm start  
Starting time 0.5 s with AC  
Starting time 0.2 s with DC  
Start at any dimming level

**AC operation:**

Mains voltage  
220–240 V 50/60 Hz  
198–264 V 50/60 Hz including safety  
tolerance ( $\pm 10\%$ )  
202–254 V 50/60 Hz including performance  
tolerance ( $+6\% / -8\%$ )

**DC operation:**

220–240 V 0 Hz  
198–280 V 0 Hz certain lamp start  
176–280 V 0 Hz operating range  
Use in emergency lighting installations according to  
EN 50172 or for emergency luminaires according  
to EN 61347-2-3 appendix J.

**Emergency units:**

The "PCA T5 ECO Ip x:itec" ballasts are compatible  
with all emergency units from TridonicAtco. See the  
table in the data sheet. Also all "5-pole" emergency  
units can be used. When used with other emergency  
units tests are necessary.

**Temperature range:**

Unlimited dimming range from 10 °C to ta max.  
-25 °C to +10 °C: dimming operation from 100 %  
to 30 %. If dimm level goes below 30 % malfunction  
possible, but no electronic ballast damage.  
This applies to AC and DC operation.

**Lamp type recognition:**

Each of the lamps for which the control gear is designed  
will be operated correctly according to the lamp  
specifications. The currently used lamp is recognised  
during the start up process.

To avoid an incorrect lamp recognition due to fast  
multiple ON/OFF switches, new lamp data are only  
restored if the lamp has operated for at least 5  
seconds.

**Mains currents in DC operation (at 70 % light output):**

wattage W	lamp type	Ballast type	Mains current at $U_n = 220 \text{ V}_{dc}$	Mains current at $U_n = 240 \text{ V}_{dc}$
1x14	T5	PCA 1x14/24 T5 ECO Ip x:itec	0.06 A	0.06 A
2x14	T5	PCA 2x14/24 T5 ECO Ip x:itec	0.12 A	0.12 A
1x24/1x14	T5/TC-L	PCA 1x14/24 T5 ECO Ip x:itec	0.10 A / 0.10 A	0.09 A / 0.09 A
2x24/2x24	T5/TC-L	PCA 2x14/24 T5 ECO Ip x:itec	0.20 A / 0.20 A	0.18 A / 0.18 A
1x21	T5	PCA 1x21/39 T5 ECO Ip x:itec	0.09 A	0.08 A
2x21	T5	PCA 2x21/39 T5 ECO Ip x:itec	0.17 A	0.16 A
1x39/1x40	T5/TC-L	PCA 1x21/39 T5 ECO Ip x:itec	0.15 A / 0.15 A	0.14 A / 0.14 A
2x39	T5	PCA 2x21/39 T5 ECO Ip x:itec	0.30 A	0.28 A
1x28	T5	PCA 1x28/54 T5 ECO Ip x:itec	0.11 A	0.11 A
2x28	T5	PCA 2x28/54 T5 ECO Ip x:itec	0.21 A	0.20 A
1x54	T5	PCA 1x28/54 T5 ECO Ip x:itec	0.21 A	0.20 A
2x54	T5	PCA 2x28/54 T5 ECO Ip x:itec	0.42 A	0.38 A
1x35	T5	PCA 1x35/49/80 T5 ECO Ip x:itec	0.14 A	0.13 A
2x35	T5	PCA 2x35/49 T5 ECO Ip x:itec	0.26 A	0.24 A
1x49	T5	PCA 1x35/49/80 T5 ECO Ip x:itec	0.18 A	0.17 A
2x49	T5	PCA 2x35/49 T5 ECO Ip x:itec	0.36 A	0.33 A
1x80	T5	PCA 1x35/49/80 T5 ECO Ip x:itec	0.30 A	0.27 A
2x80	T5	PCA 2/80 T5 ECO Ip	0.79 A	0.72 A

**Ballast lumen factor AC operation (AC-BLF) EN 60929 8.1:**

wattage W	lamp type	Ballast type	AC-BLF at $U_n = 230 \text{ V}_{AC}$
1x14	T5	PCA 1x14/24 T5 ECO Ip x:itec	1.00
2x14	T5	PCA 2x14/24 T5 ECO Ip x:itec	0.99
1x24/1x14	T5/TC-L	PCA 1x14/24 T5 ECO Ip x:itec	1.01 / 1.04
2x24/2x24	T5/TC-L	PCA 2x14/24 T5 ECO Ip x:itec	1.02 / 1.02
1x21	T5	PCA 1x21/39 T5 ECO Ip x:itec	1.03
2x21	T5	PCA 2x21/39 T5 ECO Ip x:itec	1.02
1x39/1x40	T5/TC-L	PCA 1x21/39 T5 ECO Ip x:itec	1.02 / 0.97
2x39	T5	PCA 2x21/39 T5 ECO Ip x:itec	1.02
1x28	T5	PCA 1x28/54 T5 ECO Ip x:itec	1.00
2x28	T5	PCA 2x28/54 T5 ECO Ip x:itec	1.01
1x54	T5	PCA 1x28/54 T5 ECO Ip x:itec	1.00
2x54	T5	PCA 2x28/54 T5 ECO Ip x:itec	1.01
1x35	T5	PCA 1x35/49/80 T5 ECO Ip x:itec	0.99
2x35	T5	PCA 2x35/49 T5 ECO Ip x:itec	0.98
1x49	T5	PCA 1x35/49/80 T5 ECO Ip x:itec	1.02
2x49	T5	PCA 2x35/49 T5 ECO Ip x:itec	1.00
1x80	T5	PCA 1x35/49/80 T5 ECO Ip x:itec	1.02
2x80	T5	PCA 2/80 T5 ECO Ip	1.00

The ballast lumen factor for AC operation (AC-BLF) does not alter from  $U_n = 198 \text{ V}_{AC}$  to  $U_n = 254 \text{ V}_{AC}$ .  
The ballast lumen factor for DC operation (DC-BLF) on the basis of an automatic power reduction of the ballasts  
(default value is 70 %) will be smaller than AC. It does not alter in the DC operating range (198–280 V<sub>DC</sub>).

**Harmonic distortion in the mains supply (at 230 V / 50 Hz):**

wattage W	lamp type	Ballast type	THD	3	5	7	9	11
1x14	T5	PCA 1x14/24 T5 ECO Ip x:itec	10.2	5.4	6.1	3.2	2.2	1.6
2x14	T5	PCA 2x14/24 T5 ECO Ip x:itec	7.8	4.3	2.5	2.5	2.7	2.2
1x24/1x14	T5/TC-L	PCA 1x14/24 T5 ECO Ip x:itec	6.1/6.9	4.6/5.8	1.1/1.1	1.2/1.4	1.2/1.2	1.2/1.3
2x24/2x24	T5/TC-L	PCA 2x14/24 T5 ECO Ip x:itec	4.8/8.5	3.2/6.2	1.4/1.8	2.0/2.7	1.3/1.9	1.2/1.7
1x21	T5	PCA 1x21/39 T5 ECO Ip x:itec	8.1	5.9	2.4	2.5	2.5	1.6
2x21	T5	PCA 2x21/39 T5 ECO Ip x:itec	7.2	3.6	4.4	2.5	1.5	1.5
1x39/1x40	T5/TC-L	PCA 1x21/39 T5 ECO Ip x:itec	7.0/6.2	5.5/4.7	1.1/0.7	2.1/1.4	1.5/1.0	1.3/0.9
2x39	T5	PCA 2x21/39 T5 ECO Ip x:itec	5.3	4.0	2.5	1.8	0.6	0.9
1x28	T5	PCA 1x28/54 T5 ECO Ip x:itec	9.74	3.93	3.39	2.68	2.52	2.44
2x28	T5	PCA 2x28/54 T5 ECO Ip x:itec	10.0	7.3	1.7	2.1	2.2	1.9
1x54	T5	PCA 1x28/54 T5 ECO Ip x:itec	5.6	3.5	1.5	1.6	1.1	1.3
2x54	T5	PCA 2x28/54 T5 ECO Ip x:itec	8.9	8.5	1.4	1.5	0.7	0.7
1x35	T5	PCA 1x35/49/80 T5 ECO Ip x:itec	9.1	6.0	4.2	2.2	1.9	1.8
2x35	T5	PCA 2x35/49 T5 ECO Ip x:itec	8.7	7.2	1.4	1.4	1.4	0.9
1x49	T5	PCA 1x35/49/80 T5 ECO Ip x:itec	9.6	7.8	4.3	1.8	1.0	1.0
2x49	T5	PCA 2x35/49 T5 ECO Ip x:itec	7.8	7.5	0.6	1.1	0.6	0.7
1x80	T5	PCA 1x35/49/80 T5 ECO Ip x:itec	8.1	7.8	1.6	0.6	0.5	0.6
2x80	T5	PCA 2/80 T5 ECO Ip	6.8	5.4	4.1	0.8	0.8	0.7

**Dimming:**

Dimming curve is adapted to the eye sensitiveness.  
Dimming range 1 % to 100 %  
Digital control with DSI signal:  
8 bit Manchester Code  
Speed 1 % to 100 % in 1.4 s

**Control input (D1, D2):**

Digital DSI signal, push-to-make switch (switchDIM) or a motion detector (corridorFUNCTION) can be wired on the same terminals (D1 and D2).

**Digital signal DSI:**

The control input is non-polar and protected against accidental connection with a mains voltage up to 264 V. The control signal is not SELV. Control cable has to be installed in accordance to the requirements of low voltage installations.  
Different functions depending on each module.

**SMART interface:**

An additional interface for the direct connection of the SMART-LS II Ip<sup>1)</sup> light sensor or corridorFUNCTION Plugs.

Application and functionality see corridorFUNCTION user manual.

SMART-LS II Ip<sup>1)</sup> light sensor operating mode:

The sensor registers actual ambient light and maintains the individually defined lux level.

After every mains reset the SMART interface automatically checks for an installed sensor. With the sensor installed the PCA T5 ECO Ip x!tec automatically runs in the constant lux level mode.

ON/OFF switch via mains, switchDIM or DSI signal.

DSI signal = 0 switches off,

DSI signal ≥ 1 switches on.

With switchDIM signals it is possible to change the controlled light level temporarily.

Temporarily means that after a switching cycle OFF/ON command the ballast will start at the preset value determined by the SMART-LS II Ip. The installation of the two wire bus is according to the appropriate low voltage regulations.

**switchDIM:**

Integrated switchDIM function allows a direct connection of a push to make switch for dimming and switching.  
Brief push (< 0.6s) switches ballast ON and OFF. The ballasts switch-ON at light level set at switch-OFF. When the push to make switch is held, PCA ballasts

**Dimming characteristics**

**PCA T5 ECO Ip x!tec**

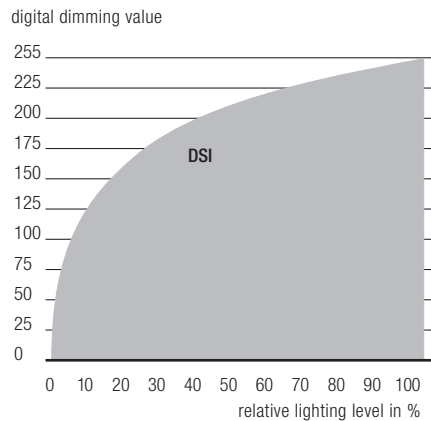

Dimming characteristics as seen by the human eye

**Energy saving**

**PCA T5 ECO Ip x!tec**

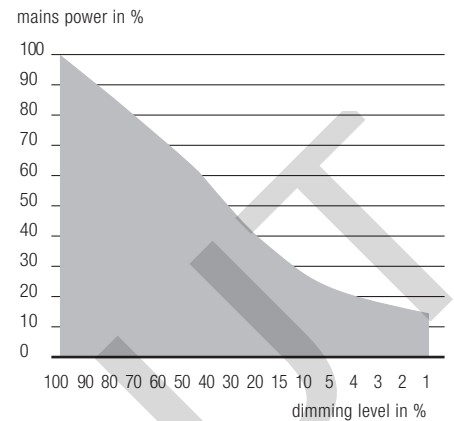

are dimmed. After repush the PCA is dimmed in the opposite direction.

The switchDIM fade time is set to 3s from min. to max. in the factory settings. With a 20s push to the push to make switch this fade time can be changed to 6s. In this instance the switchDIM application will be synchronized to 50 % light level after 10s and after 20s the light level rises to 100 % with the new fade time.

At every synchronization (10s keystroke) the device will reset to 3s (factory setting)

In installations with PCAs with different dimming levels or opposite dimming directions (e.g. after a system extension), all PCAs can be synchronized to 50 % dimming level by a 10s push.

Use of push to make switch with indicator lamp is not permitted.

Deactivation: If the corridorFUNCTION is wrongly activated in a switchDIM system (for example a switch is used instead of pushbutton), there is the option of installing a pushbutton and deactivating the corridorFUNCTION mode by five short pushes of the button within three seconds.

switchDIM and corridorFUNCTION are very simple tools for controlling ballasts with conventional momentary-action switches or motion sensors.

To ensure correct operation a sinusoidal mains voltage with a frequency of 50 Hz or 60 Hz is required at the control input.

Special attention must be paid to achieving clear zero crossings. Serious mains faults may impair the operation of switchDIM and corridorFUNCTION.

**Backwards compatibility:**

With a simple key combination a PCA T5 ECO Ip x!tec can be reset as a normal PCA ECO from the previous generation. Synchronisation simply has to take place three times within one minute (3x 10s).

To activate the "x!tec" settings again, synchronisation has to take place four times within one minute.

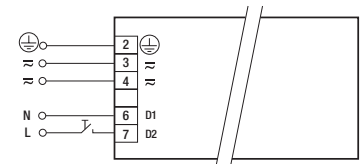

switchDIM PCA T5 ECO Ip x!tec

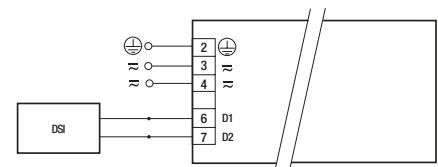

DSI PCA T5 ECO Ip x!tec

Dimmable ballasts from TridonicAtco have to be earthed.

<sup>1)</sup> SMART-LS II Ip: article number 86458258

**Loading of automatic circuit breakers:**

Automatic circuit breaker type	C10	C13	C16	C20	B10	B13	B16	B20
Installation Ø	1.5 mm <sup>2</sup>	1.5 mm <sup>2</sup>	1.5 mm <sup>2</sup>	2.5 mm <sup>2</sup>	1.5 mm <sup>2</sup>	1.5 mm <sup>2</sup>	1.5 mm <sup>2</sup>	2.5 mm <sup>2</sup>
PCA 1x14/24 T5 ECO Ip x!tec	50	80	110	135	25	40	75	90
PCA 2x14/24 T5 ECO Ip x!tec	24	34	48	52	12	17	24	26
PCA 1x21/39 T5 ECO Ip x!tec	34	50	76	86	17	25	38	43
PCA 2x21/39 T5 ECO Ip x!tec	16	22	32	36	8	11	16	18
PCA 1x28/54 T5 ECO Ip x!tec	24	34	48	52	12	17	24	26
PCA 2x28/54 T5 ECO Ip x!tec	16	22	32	34	8	11	16	17
PCA 1x35/49/80 T5 ECO Ip x!tec	16	24	32	38	8	12	16	19
PCA 2x35/49 T5 ECO Ip x!tec	16	22	32	34	8	11	16	17
PCA 2/80 T5 ECO Ip	10	14	20	22	5	7	10	11

Continuous operation: to calculate the protective safety switch see main current, page 1



#### corridorFUNCTION

Activation: To activate the corridorFUNCTION a voltage of 230V simply has to be applied for five minutes at D1, D2. The unit will then switch automatically to the corridorFUNCTION.

Deactivation: If the corridorFUNCTION is wrongly activated in a switchDIM system (for example a switch is used instead of pushbutton), there is the option of installing a pushbutton and deactivating the corridorFUNCTION mode by five short pushes of the button within three seconds.

The corridorFUNCTION V2 offers the added benefit of a second and third preprogrammed profile, which can be activated by the corridorFUNCTION plugs.

Application and functionality of profiles see user manual.



#### Intelligent Temperature Guard

The intelligent temperature guard protects the PCA T5 ECO Ip x:tec from thermal overheating by reducing the output power or switching off in case of operation above the thermal limits of the luminaire or ballast. Depending on the luminaire design, the ITG operates at about 5 to 10 °C above Tc temperature.



#### Intelligent Voltage Guard

Intelligent Voltage Guard is the name of the new electronic monitor from TridonicAtco. This innovative feature of the PCA family of control gear from TridonicAtco immediately shows if the mains voltage rises above or falls below certain thresholds. Measures can then be taken quickly to prevent damage to the control gear.

- If the mains voltage rises above approx. 305 V (voltage depends on the ballast type), the lamp starts flashing on and off.
- This signal "demands" disconnection of the power supply to the lighting system.
- The active-current-control of these control gears is protected against failure caused by the high mains currents generated as a result of mains undervoltage. The switch off level depends on lamp wattage and is typically < 140 V.

#### Operating voltage:

Wattage W	lamp type	Ballast type	U <sub>out</sub>
1x14	T5	PCA 1x14/24 T5 ECO Ip x:tec	400 V
2x14	T5	PCA 2x14/24 T5 ECO Ip x:tec	400 V
1x24 / 1x14	T5/TC-L	PCA 1x14/24 T5 ECO Ip x:tec	400 V / 400 V
2x24 / 2x24	T5/TC-L	PCA 2x14/24 T5 ECO Ip x:tec	400 V / 400 V
1x21	T5	PCA 1x21/39 T5 ECO Ip x:tec	400 V
2x21	T5	PCA 2x21/39 T5 ECO Ip x:tec	400 V
1x39 / 1x40	T5/TC-L	PCA 1x21/39 T5 ECO Ip x:tec	400 V / 400 V
2x39	T5	PCA 2x21/39 T5 ECO Ip x:tec	400 V
1x28	T5	PCA 1x28/54 T5 ECO Ip x:tec	430 V
2x28	T5	PCA 2x28/54 T5 ECO Ip x:tec	430 V
1x54	T5	PCA 1x28/54 T5 ECO Ip x:tec	430 V
2x54	T5	PCA 2x28/54 T5 ECO Ip x:tec	430 V
1x35	T5	PCA 1x35/49/80 T5 ECO Ip x:tec	430 V
2x35	T5	PCA 2x35/49 T5 ECO Ip x:tec	430 V
1x49	T5	PCA 1x35/49/80 T5 ECO Ip x:tec	430 V
2x49	T5	PCA 2x35/49 T5 ECO Ip x:tec	430 V
1x80	T5	PCA 1x35/49/80 T5 ECO Ip x:tec	430 V
2x80	T5	PCA 2/80 T5 ECO Ip	430 V

#### Installation instructions:

##### Wiring type and cross section:

The wiring can be solid cable with a cross section of 0.5 to 0.75 mm<sup>2</sup> for push terminal and 0.5 mm<sup>2</sup> for IDC terminal. For the push-wire connection you have to strip the insulation (8–9 mm).

##### Wiring advice:

The lead length is dependent on the capacitance of the cable.

Ballast Type	Terminal		Maximum capacitance allowed	
	Cold	Hot	Cold	Hot
PCA 1/xx T5 ECO Ip x:tec	11, 12	9, 10	200 pF	100 pF
PCA 2/xx T5 ECO Ip x:tec	11, 12, 13, 14	9, 10, 15, 16	200 pF	100 pF

With standard solid wire 0.5/0.75 mm<sup>2</sup> the capacitance of the lead is 30–80 pF/m.

This value is influenced by the way the wiring is made.

Lamp connection should be made with symmetrical wiring.

Hot leads (9, 10, 15, 16) and cold leads (11, 12, 13, 14) should be separated as much as possible.

When using two or more dimmable ballasts in one luminaire with separate dimming controls, the lamp leads must be kept separate.

Dimmable ballasts from TridonicAtco have to be earthed.

wire preparation:  
0.5 – 0.75 mm<sup>2</sup>

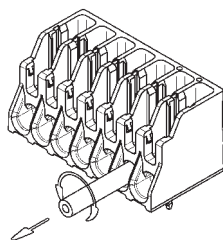
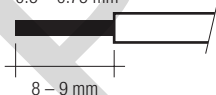

Loosen wire through  
twisting and pulling

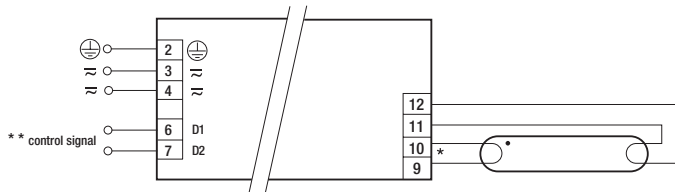

\* leads 9, 10: keep wires short, max. 1.0 m  
leads 11, 12: max. 2.0 m; ballast must be earthed  
\*\* digital signal DSI or switchDIM

PCA T5 ECO Ip x:tec 1x14-80W

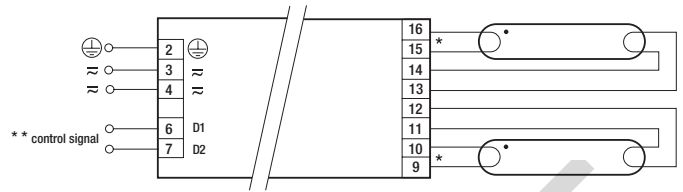

\* leads 9, 10, 15, 16: keep wires short, max. 1.0 m  
leads 11, 12, 13, 14: max. 2.0 m; ballast must be earthed  
\*\* digital signal DSI or switchDIM

PCA T5 ECO Ip x:tec 2x14-49W

PCA T5 ECO Ip 2/80W

Dimmable ballasts from TridonicAtco have to be earthed.

#### RFI:

- Connection to the lamps of the hot leads must be kept as short as possible
- Mains leads should be kept apart from lamp leads (ideally 5–10 cm distance)
- Do not run mains leads adjacent to the electronic ballast
- Twist the lamp leads
- Keep the distance of lamp leads from the metal work as large as possible
- Mains wiring to be twisted when through wiring
- Keep the mains leads inside the luminaire as short as possible

#### General advise:

Electronic ballasts are virtually noise free. Magnetic fields generated during the ignition cycle can cause some background noise but only for a few milliseconds.

#### Operation on DC voltage:

Our ballasts are constructed to operate DC voltage and pulsed DC voltage. To operate ballasts with pulsed DC voltage the polarity is absolute mandatory.



#### Isolation and electric strength testing of luminaires:

Electronic devices can be damaged by high voltage. This has to be considered during the routine testing of the luminaires in production.

According to IEC 60598-1 Annex Q (informative only!) or ENEC 303-Annex A, each luminaire should be submitted to an isolation test with 500 V DC for 1 second. This test voltage should be connected between the interconnected phase and neutral terminals and the earth terminal.

The isolation resistance must be at least 2 MΩ.

As an alternative, IEC 60598-1 Annex Q describes a test of the electrical strength with 1500 V AC (or 1.414 x 1500 V DC). To avoid damage to the electronic devices this test must not be conducted.

① For further technical information please visit [www.tridonicatco.com](http://www.tridonicatco.com)